

VII. Reactions of Alkenes: Electrophilic Addition

The most characteristic reaction of alkenes is an *Electrophilic Addition Reaction*.

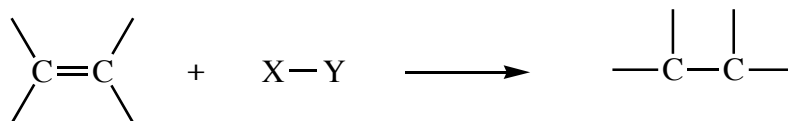

Examples:

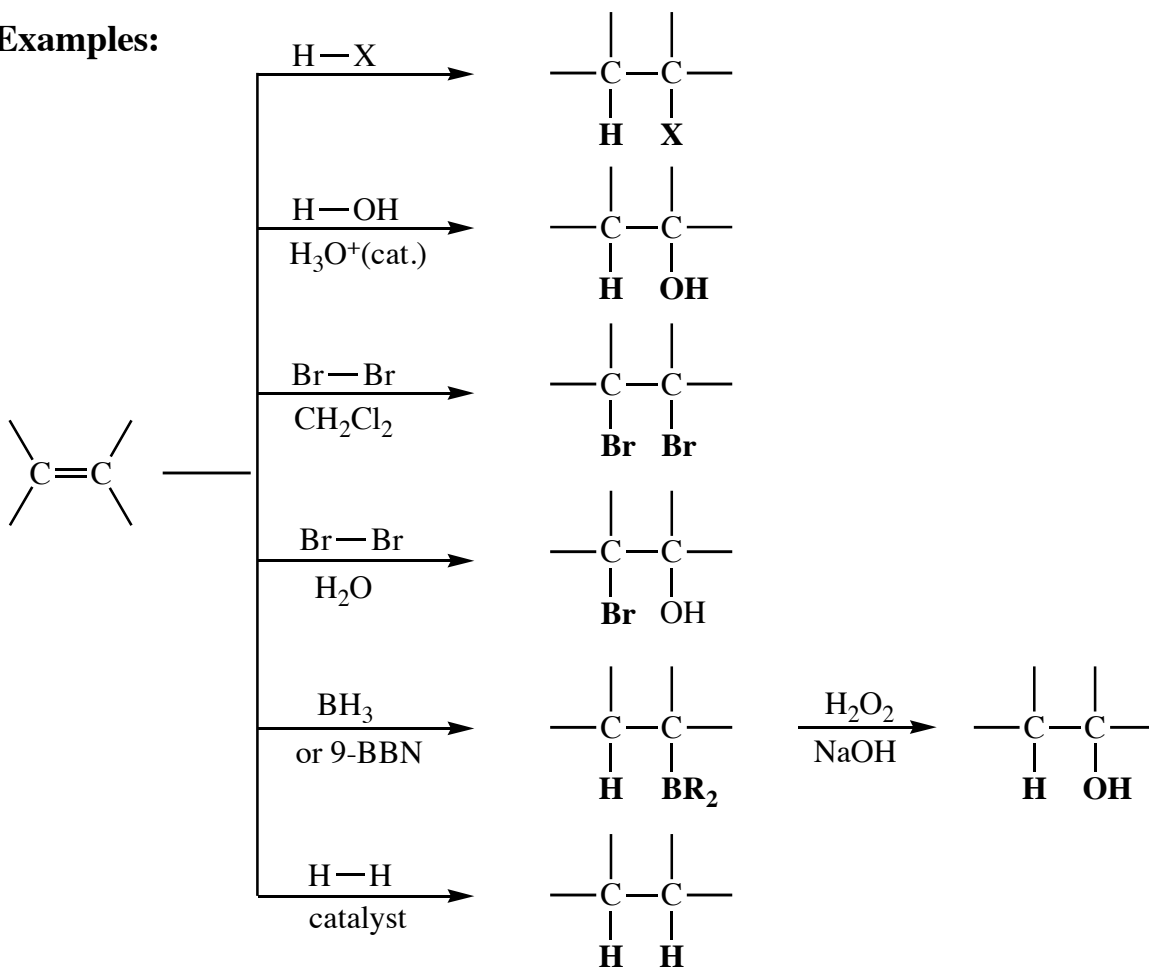

VIII. Addition of Hydrogen Halides to Alkenes

The hydrogen halides H-Cl, H-Br, and H-I undergo addition to carbon bonds to give alkyl halides.

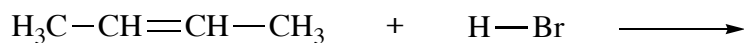

When the alkene has an *unsymmetrically* located double bond, two isomeric products are possible:

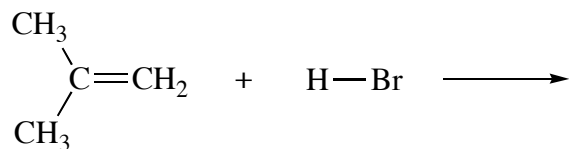

- The main product is the one in which the halogen is bound to the carbon of the double bond with the greatest number of alkyl substituents.
- A reaction that gives only one of several possible constitutional isomers is said to be a **regioselective** reaction.
- Hydrogen halide addition to alkenes is **regioselective** and follows **Markovnikov's rule**:

Markovnikov's rule: "The halogen of hydrogen halide attaches itself to the carbon of the alkene bearing the least number of hydrogens and the greater number of carbons."

Q. How can we explain the regioselectivity of this reaction?

A. To answer, we have to look at the mechanism:

The rate law for a chemical reaction often gives clues to the **mechanism** for a reaction. A **mechanism** is a complete description of a reaction pathway, including any reactive intermediates.

Kinetics: If we measure the rate of the reaction as a function of varying initial concentrations of reactants we find that:

We can conclude that:

- the reaction is second order
- the reaction is bimolecular

Mechanism:

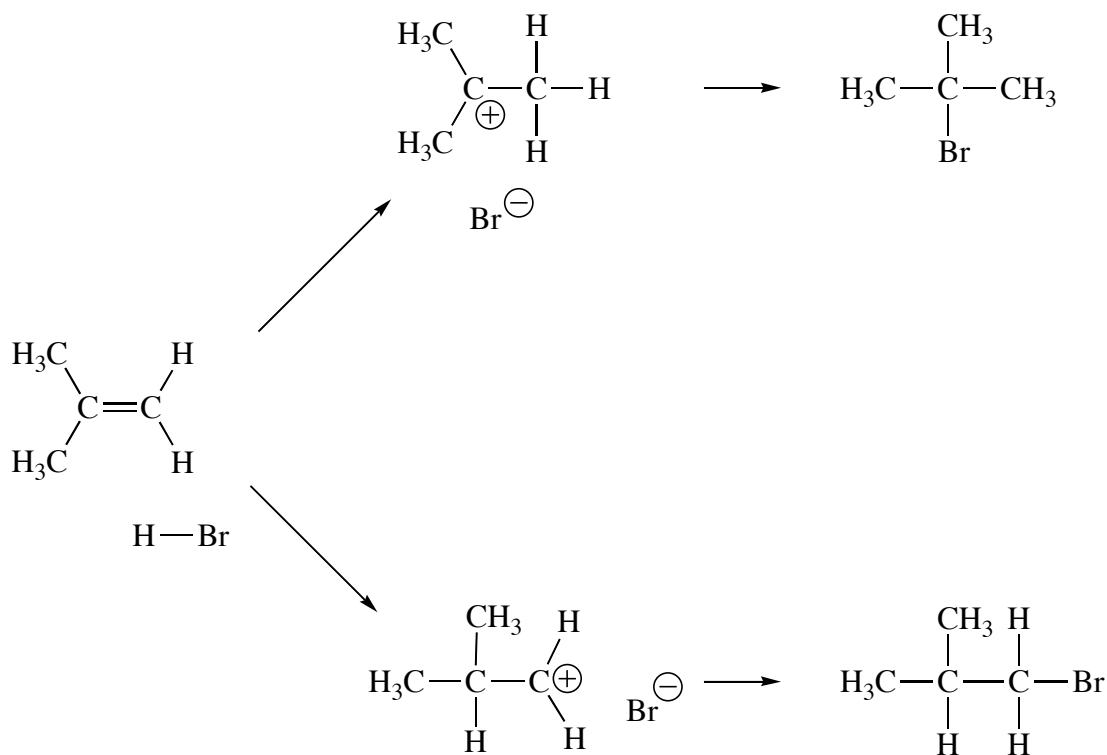

Important points about this mechanism:

1. In the first reaction, which is the rate-determining step, the *electron pair* of the π -bond attacks the proton of the hydrogen halide. A π -bond is a very weak base that can be protonated to a small extent by *very strong acids*.
2. The resulting carbocation is a powerful electron deficient Lewis acid, and thus a potent electrophile. There are two possible carbocations that can form in this reaction, a *tert*-butyl cation, or an isobutyl cation.
3. In the second reaction, the *carbocation* reacts rapidly with nucleophilic halide ion. If the *tert*-butyl cation is formed, it will react with bromide ion to form *tert*-butyl bromide. If the isobutyl cation is formed, it will react with bromide ion to form isobutyl bromide.
4. These two reactions are in **competition** - that is one can only happen at the expense of the other because they compete for the same starting material.
5. The only product formed in this reaction is *tert*-butyl bromide, so the *tert*-butyl cation must be formed exclusively in this reaction. **Why?**

THE REGIOSELECTIVITY OF THE HYDROGEN HALIDE ADDITION IS DUE TO THE FORMATION OF THE MORE STABLE CARBOCATION INTERMEDIATE!

Markovnikov's rule: For addition of an unsymmetrical electrophilic reagent to a double bond, *the major product comes from the more stable (lower energy) carbocation intermediate.*

Look @ the Energy Diagram:

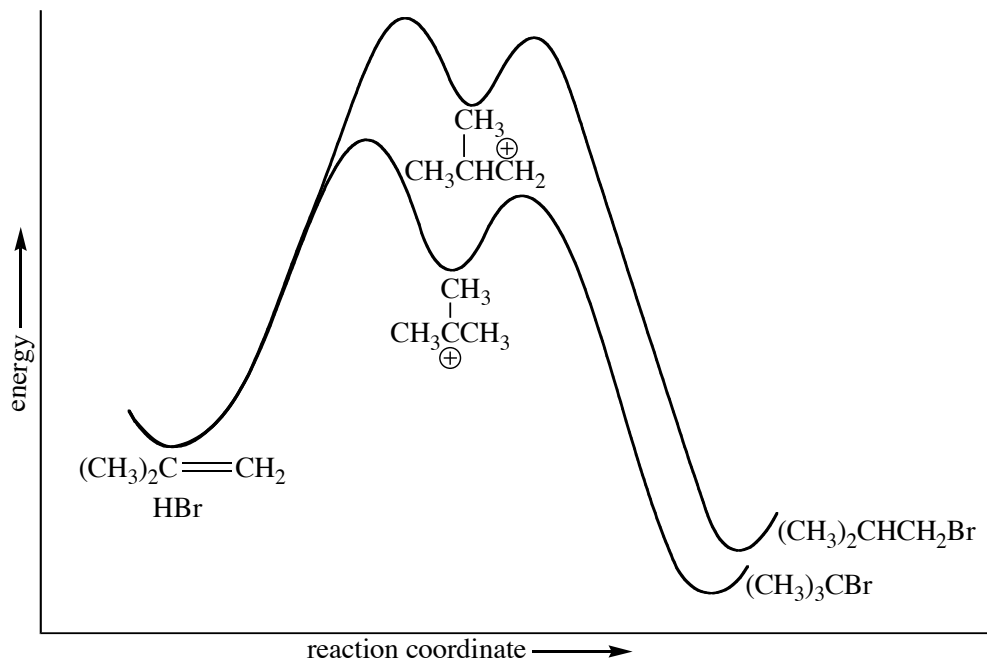

- ❖ Because the formation of the carbocation is the rate-determining step in this reaction, the relative rates of formation of the two carbocations determine the relative amounts of each product formed in the reaction.
- ❖ The relative rates of formation of the two carbocations is determined by the relative energies of the transition states for carbocation formation.
- ❖ Hammond's Postulate gives us an approximation of the relative energies of the two transition states. According to Hammond's Postulate, the transition state of a reaction resembles the structure of the species (*reactant or product*) to which it is closer in energy.

∴ Since the carbocations have a *very different* energies, the transition states also have *very different* energies.

Q: What happens when two approximately equivalent carbocations are formed?

A:

Example:

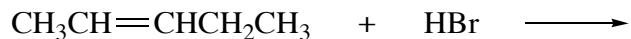

IMPORTANT POINT: Because the intermediate in this reaction is a carbocation, *watch for rearrangements!*

Example:

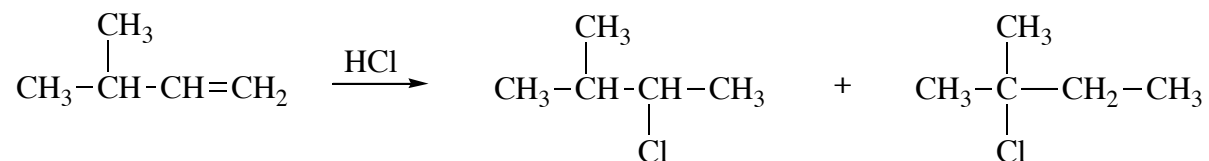

How?

A. Stereochemistry of Electrophilic Addition of HX

Two factors are important when considering the stereochemistry of electrophilic addition of H-X to an alkene:

- 1. Achiral reactants yield achiral or racemic products.** So if a chemical reaction of achiral reactants yields a chiral product (a product with a new stereocenter), the product will be a racemic mixture.
- 2. Carbocations react with reagents from the top or the bottom with equal probability.**

Example:

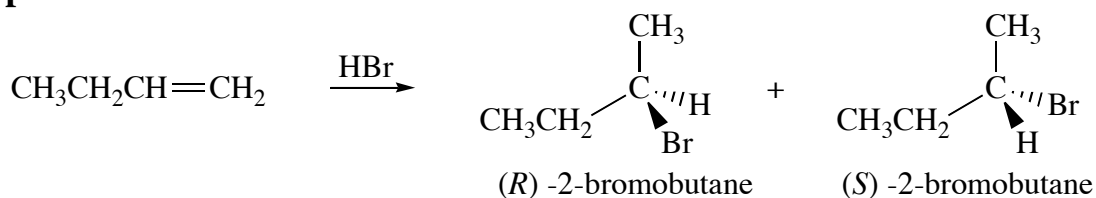

This is easy to see if you consider the mechanism:

IX. Addition of Water to Alkenes

When water is added to an alkene, **no reaction takes place because water is not electrophilic enough to add to the alkene double bond**. If, however, a strong acid, such as H_2SO_4 or HCl is added (*in catalytic amounts*), addition takes place to form an alcohol. Addition of water to a molecule is called **hydration**.

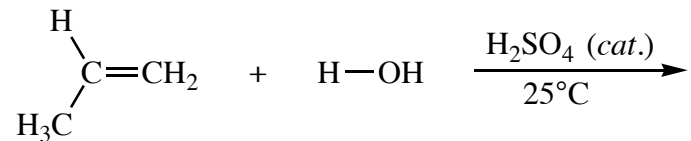

This reaction is regioselective and follows Markovikov's rule:

For addition of an unsymmetrical electrophilic reagent to a double bond, *the major product comes from the more stable (lower energy) carbocation intermediate.*

Mechanism for Hydration:

Important Points about this reaction:

1. Notice that in the first step of hydration, a carbocation is formed. It is the rate-limiting step. Because this is the rate-limiting step, the rate of the reaction is increased when the rate of this step is increased!

Compare:

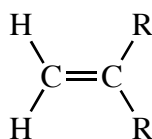

vs.

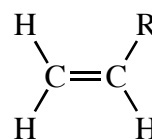

2. Just like with electrophilic addition of HX, the SN1, and the E1 reaction, whenever carbocations are formed watch for rearrangements!
3. H₂O attacks the carbocation equally from the top and the bottom.

Look @ the energy diagram for this reaction:

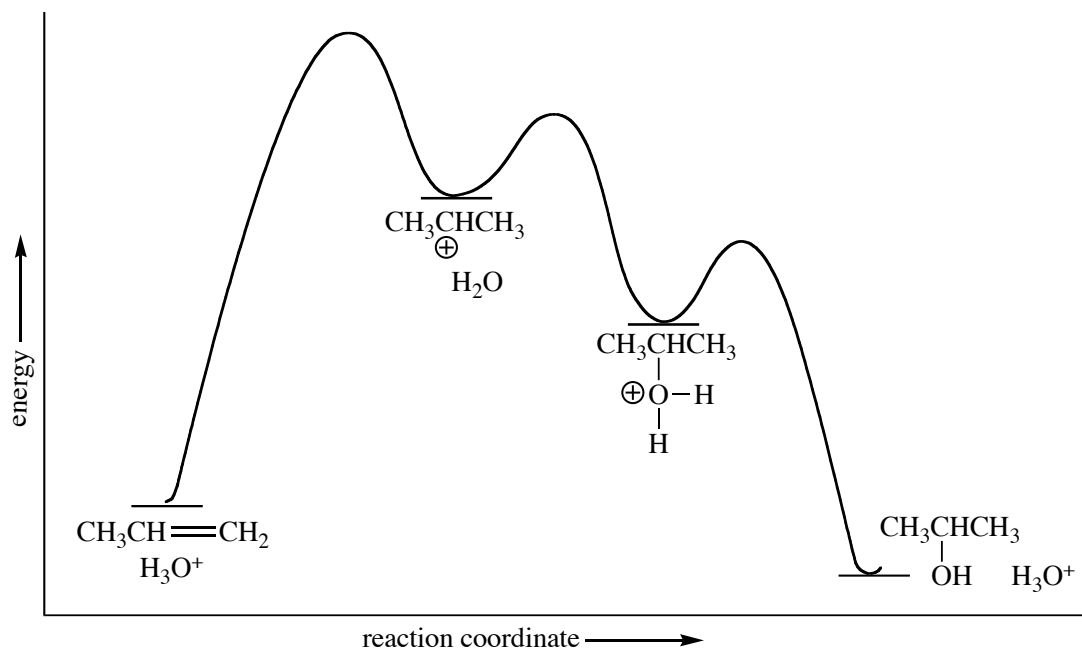

- This is a 3-step reaction, so there are 3 transition states for this reaction.
- Formation of the carbocation is the rate-determining step.

4. **Notice that hydration of an alkene is the reverse of dehydration of an alcohol!**

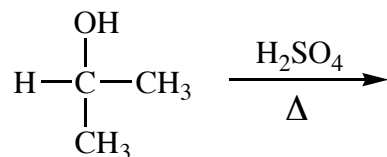

Compare the mechanism for hydration with the mechanism for dehydration:

Principle of Microscopic Reversibility: The forward reaction and the reverse reaction taking place under the same conditions (*as in an equilibrium*) must follow the same reaction pathway in microscopic detail.

Because all of these steps are reversible, this is an equilibrium process. *The ultimate product obtained will depend on the position of the equilibrium.*

☞ *To favor dehydration:* alcohol, concentrated acid, and Δ (so concentration of H_2O is low.)

☞ *To favor hydration:* alkene + dilute acid, low temp

X. Addition of Bromine & Chlorine to Alkenes

The halogens Br_2 and Cl_2 also add to alkenes. This may be surprising, since it is not obvious that Br_2 or Cl_2 are electrophiles. Halogens add to π -bonds because halogens are polarizable. The electron-rich double bond induces a dipole in an approaching halogen molecule, making one halogen atom electron-deficient, and the other electron-rich ($\text{X}^{\delta+}\text{X}^{\delta-}$). The electrophilic halogen atom is then attracted to the nucleophilic double bond, making addition possible.

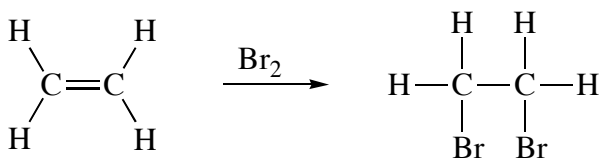

You might predict that the mechanism is similar to that for $\text{H}-\text{Br}$ addition. The product of the first step is *not* a carbocation, however. *How do we know?*

Prediction:

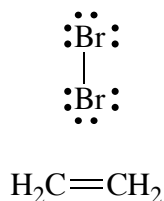

Two things are inconsistent with carbocation formation:

1. There are never rearranged products.
2. The reaction is stereoselective! Attack takes place on only one side.

An example showing stereochemistry:

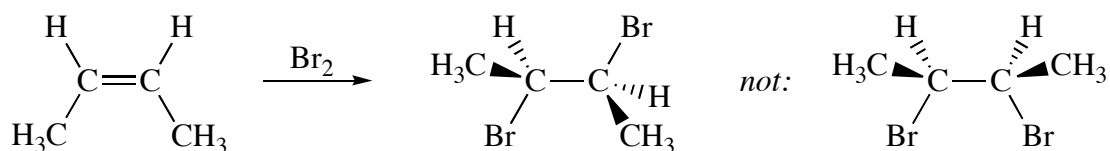

Mechanism:

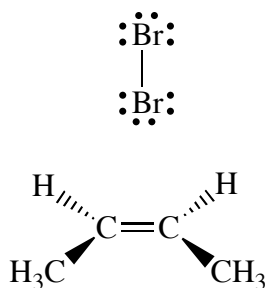

*In the vicinity of the π -electron cloud, the Br-Br bond becomes polarized

How is the enantiomer formed?

Bromine
comes in
from
bottom:

or

Bromine
attacks @
right side:

Important points about the halogenation reaction:

- Unlike a normal carbocation, all of the octets are satisfied in the bromonium ion. The bromonium ion has considerable ring strain, however, and there is a positive charge on the bromine atom, so this is a reactive intermediate.
- Because a carbocation does not form in this reaction, no rearrangements are seen.
- The product results from stereoselective **anti** addition to the double bond.
- This reaction does not work with F_2 (*it reacts explosively*), nor with I_2 (*it is thermodynamically unfavorable – the vicinal diiodides formed are unstable*)
- The reaction is typically run in an inert solvent such as CH_2Cl_2 or CCl_4 .

If the reaction is run in H_2O rather than CH_2Cl_2 , a different product is obtained as the major product:

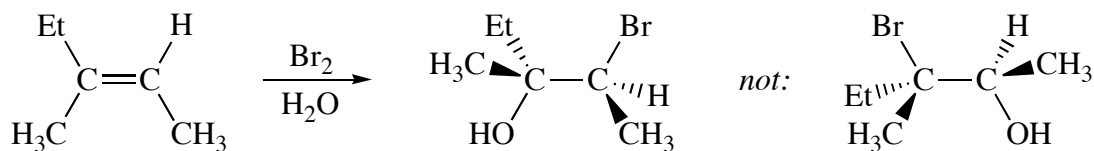

- A bromonium ion also forms in this reaction. In the second step, however, the bromonium ion reacts with the first nucleophile it bumps into:

Mechanism:

Q: *How do we explain the regiochemistry in this addition?*

A: Notice, the nucleophile, H_2O , attacks the most-substituted carbon. This is reminiscent of the acid catalyzed ring opening of an epoxide (Chapter 9.15B):

Recall:

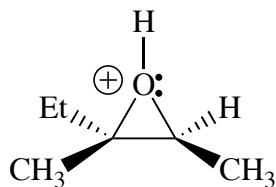

We can use the same explanation we used back in Chapter 9, namely, the nucleophile attacks the more-substituted carbon of the bridged halonium ion because that carbon bears more δ^+ charge, and is thus the most electron-deficient:

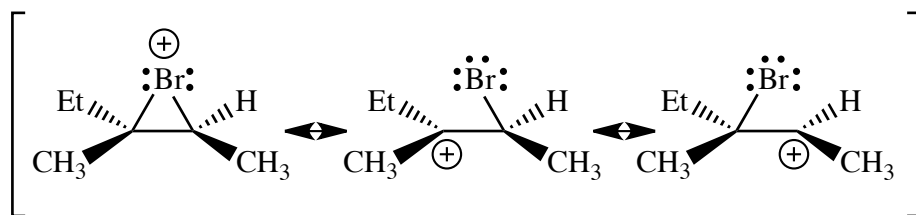

Hybrid of best two resonance structures:

The same thing happens when bromine is added to unsymmetrical alkenes, it is just that we can't detect it:

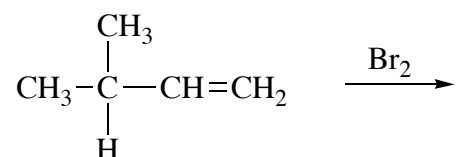

XI. Addition of Borane: Hydroboration/Oxidation

Borane (BH_3) is another electrophile that adds to alkenes. When the addition is complete, H_2O_2 and NaOH are added to give an alcohol. The regiochemistry of this reaction is the opposite of the regiochemistry of HX and H_2O addition, and thus it is an *anti-Markovnikov addition*:

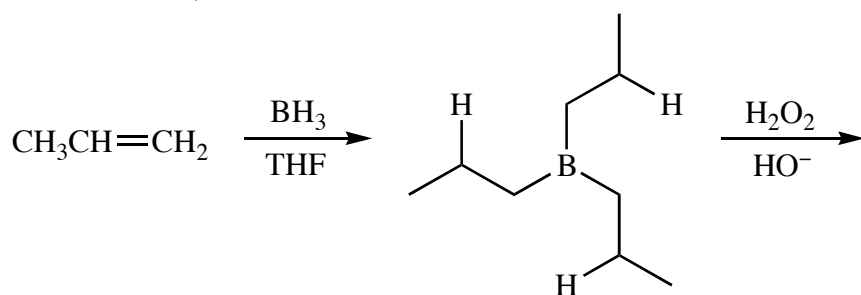

* *B-H adds to alkene*

* *Oxidation replaces B w/ OH*

Typical Reaction:

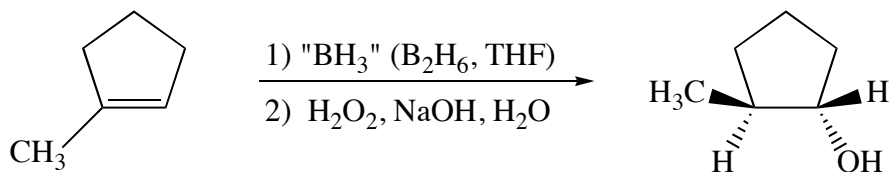

Result:

- Highly regioselective and stereoselective reaction.
- **Anti-Markovnikov addition of H₂O to an alkene**

- H and OH are added to the same side of the molecule (**syn addition**)
- *no* rearrangements are observed

Mechanism:

Step 1. Hydroboration: BH₃ is a Lewis Acid and therefore an electrophile:

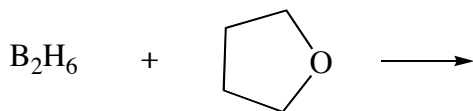

BH₃ reacts with the π-electrons of the alkene to form a 4-centered T.S.:

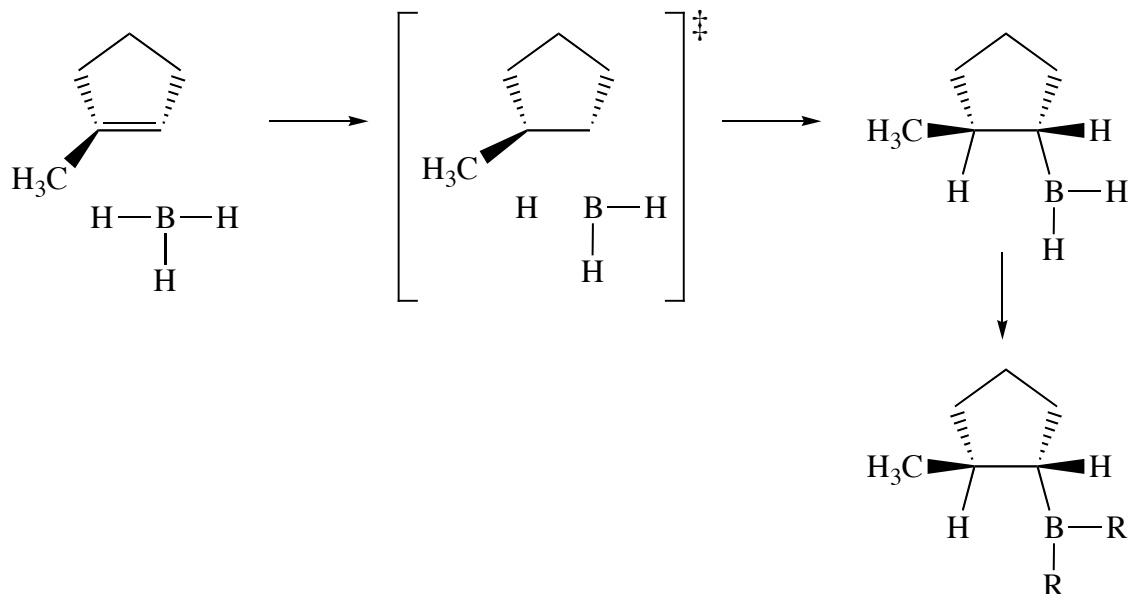

3 things to notice:

1. The $\delta+$ charge is at the carbon that will lead to the most stable carbocation.
2. The bulkier BH_3 group is on the least substituted side.
3. Boron & Hydrogen are added to the same side of the molecule

Step 2. Oxidation of the Organoborane

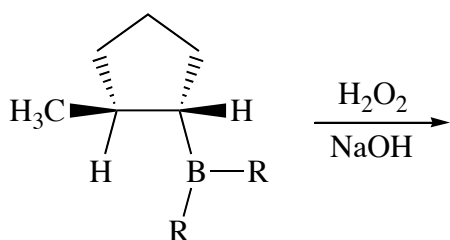

Regioselectivity in Hydroboration Reactions:

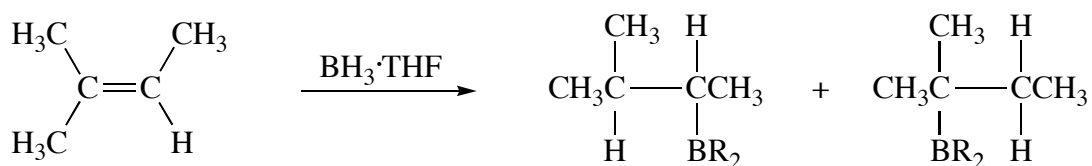

For *approximately* symmetrically disubstituted alkenes, you get mixtures of products with BH_3 :

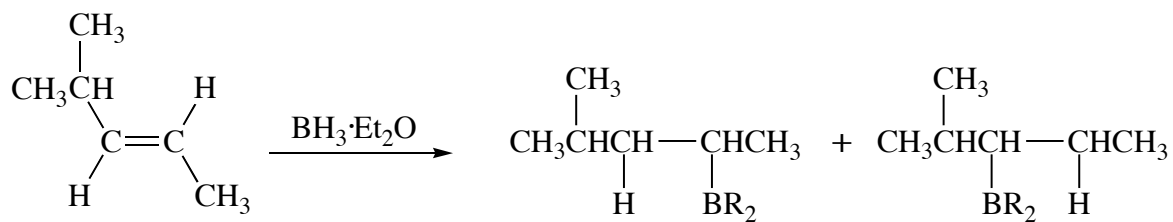

Solution: Use a bulkier reagent, so that steric interactions become more important:

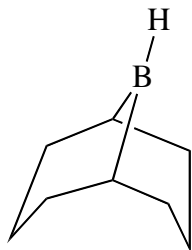

Advantages of using 9-BBN (9-Borobicyclononane):

- Reasonably stable (B_2H_6 reacts violently with air and is a gas)
- Bulkiness gives it high selectivity

Compare:

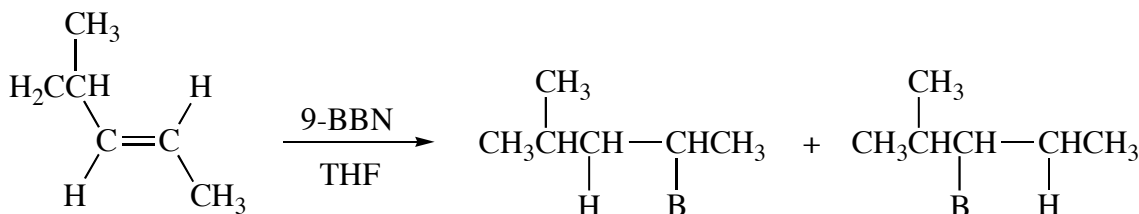

Stereoselectivity in Hydroboration Reactions:

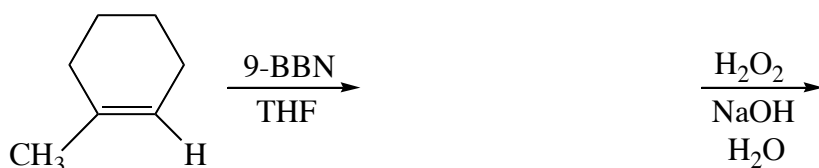

- ◆ Hydroboration followed by oxidation results in the overall **syn addition** of H_2O to a double bond.

Comparing hydration methods:

Hydration (H_2O , H_3O^+) and Hydroboration/Oxidation (BH_3 , then HO^- and H_2O_2) both add the elements of H_2O across a double bond, but they give different isomers as products.

Example:

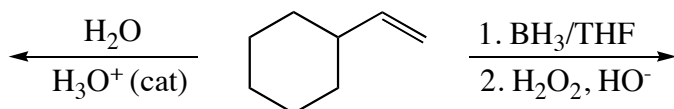

XII. Reactions and Synthesis

Alkenes are a central functional group in organic chemistry. They are easily prepared by elimination or dehydration reactions. Because their π -bonds are easily broken, they undergo addition reactions to prepare a variety of useful compounds.

Example 1: Synthesis the following compound from the given starting material:

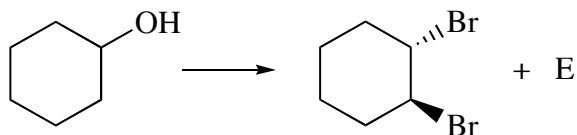

Example 2: The following synthesis looks harder but really isn't:

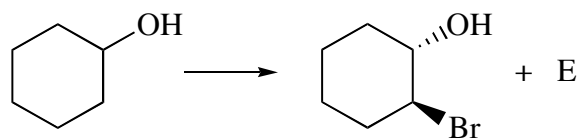

Example 3:

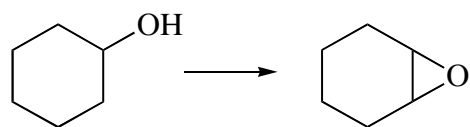

Attributions

Page 56: Cis-trans isomers:

By Foobar [GFDL (<http://www.gnu.org/copyleft/fdl.html>), CC-BY-SA-3.0 (<http://creativecommons.org/licenses/by-sa/3.0/>) or CC BY 2.5 (<http://creativecommons.org/licenses/by/2.5>)], via Wikimedia Commons